

UDC 621.31, 629.1.07

O.O.Beshta¹

¹Dnipro University of Technology, Dnipro, Ukraine, e-mail: beshta.o.o@nmu.one; khudolii.s.s@nmu.one

S.S.Khudolii¹

M.Neuburger²

²University of Applied Science "Hochschule Esslingen", Goppingen, Germany

N.Neuberger²

CONTROL OF ENERGY FLOWS IN ELECTRIC DRIVETRAIN OF ELECTRIC VEHICLE WITH EXTRA DC SOURCE

О.О.Бешта¹

¹Національний технічний університет «Дніпровська політехніка», e-mail: beshta.o.o@nmu.one; khudolii.s.s@nmu.one

С.С. Худолій¹

М. Нойбургер²

²Університет прикладних наук «Хохшуде Есслінген», Гьоппінген, Німеччина

Н. Нойбергер²

КЕРУВАННЯ ПОТОКАМИ ЕНЕРГІЇ В ПРИВОДІ ЕЛЕКТРОМОБІЛЯ З ДОДАТКОВИМ ДЖЕРЕЛОМ ПОСТІЙНОГО СТРУМУ

А.А.Бешта¹

¹Национальный технический университет «Днепро́вская политехника», e-mail: beshta.o.o@nmu.one; khudolii.s.s@nmu.one

С.С. Худолей¹

М. Нойбургер²

²Университетт прикладных наук «Хохшуде Эсслинген», Гёппинген, Германия

Н. Нойбергер²

УПРАВЛЕНИЕ ПОТОКАМИ ЭНЕРГИИ В ПРИВОДЕ ЭЛЕКТРОМОБИЛЯ С ДОПОЛНИТЕЛЬНЫМ ИСТОЧНИКОМ ПОСТОЯННОГО ТОКА

Purpose. Development of control approach for the inverter in electric vehicle's drivetrain in order to simultaneously control the energy flows from two DC sources

Methodology. Methods of mathematical modeling and simulation have been used in research modes of AC and DC components using one inverter. Also, a comparative analysis method was applied to select the optimal method for implementing the control algorithm.

Findings. New approach for supplying asynchronous motor from two DC sources is suggested. The approach requires special scheme when the second DC source is connected to the neutral point of the motor's Y-connected stator windings. The valve switching sequence is described and the performances of the motor within this scheme.

Originality. Connection of DC source to a common (zero) point of the AC electric motor when the latter is fed from the three-phase frequency converter, allows to transmit the energy to the motor without the dedicated converter. Special valve switching algorithm for separate control of power flows.

Practical value. The new scheme combines several electric power sources controlled by single combined converter, which simplifies the electric drivetrain in hybrid and electric vehicles.

Keywords: *electric vehicle, combined electromechanical converter, DC power sources, electric drive*

Introduction

Recently, worldwide interest in alternative types of vehicles has increased. Since 2010, hybrid and electric vehicles have been actively produced by large automotive corporations, and sales have doubled every year. In Ukraine, the growth rate of sales of electric vehicles exceeds 300-400% per year. There electric transportation market is very promising. Therefore, many car manufacturers are developing and selling their first electric models. The drive of typical electric vehicle is safer and simpler technically, because it has less wear parts, besides, it is more efficient and environmentally friendly. The main advantage of electric vehicles is that they do not emit exhaust gases during the work phase. Other advantage of electric vehicles is their quiet operation. The use of electric vehicles will significantly reduce the noise level in cities. Electric cars will be more competitive with conventional vehicles when certain problems associated with their operation are resolved.

The biggest drawback of electric cars is their short travelling range, which is limited by the capacity of the battery pack. Modern battery technology allows you to drive about 150-200 km on a single charge. This indicator depends on the size of the vehicle, the weight and capacity of the battery and driving conditions. However, the short run of electric vehicles is not the main problem. While conventional vehicles can be charged in a couple of minutes, electric vehicle batteries, if they are discharged, need several hours for charging. Therefore, reaching somewhere at the distance of 500 km becomes very difficult. Of course, at the moment there are various types of "fast" charging stations for electric vehicles. The main idea of these charging stations is that the car's charging capacity can be increased, thereby reducing time costs. But even under these conditions, filling up a full tank of fuel is several times faster than filling up electricity at a "fast" charging station.[1]

Nowadays, the concepts of electric vehicle charge while driving from independent, alternative sources of electrical energy are being considered. This method involves the use of multiple sources of electrical energy. There may be several options: galvanic battery and fuel cell, a battery and a supercapacitor, and finally, galvanic battery and solar panel. The combined use of several accumulators / sources will allow the best use of the

advantages of each of them, for example, high specific energy consumption of hydrogen elements and high peak power of supercapacitors, free energy of solar energy, etc.[2]

Due to its accessibility, solar energy is becoming more and more used. In middle latitudes, the average sun energy is about 1.1-1.2 kW / m². Taking into account the efficiency of modern solar panels and the surface area of the car, using photovoltaic cells mounted on the car can yield 2-3 kW of electrical power. This is not so little, considering that for driving at 60 km/h, the drive of a middle-class sedan should develop only 6-8 kW. It is because of the need to accelerate faster that modern cars have way more powerful engines than 6-8 kW. [3]

In electric vehicles, as a rule, AC electric motors, such as asynchronous or synchronous motors with permanent magnets, are used. The motor is controlled by a DC/AC converter. The standard electric vehicle's drivetrain is shown in Figure 1.

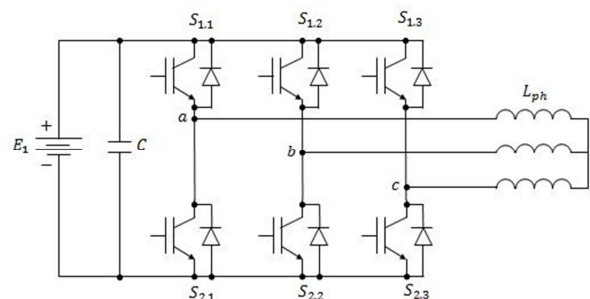

Fig.1. Standard scheme of building an electric vehicle drive

This scheme provides the regulation of the supply voltage and frequency applied to the electric motor using PWM modulation. The sequence of transistors state (100, 110, 010, 011, 001, 101, 100) (where each '1' corresponds the open state of the transistor in the upper leg while the one in the lower leg is always inverse) makes counter-clockwise rotating space vector, which jumps by the angle of $\pi/3$ (Fig.2).

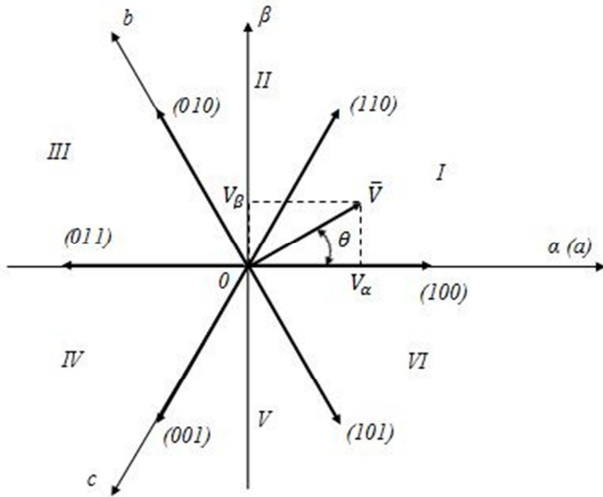

Fig.2. Voltage vector diagram

For specified sequence, when combination (100) takes place, the equivalent circuit looks like it is shown in Fig. 3.

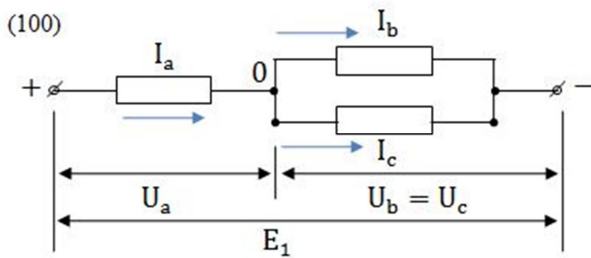

Fig.3 Equivalent circuit for (100) combination

As can be seen from Fig. 3, the sequence (100) has such values $U_a = \frac{2}{3}E_1$, a $U_b = U_c = \frac{E_1}{3}$. [4]

It can be noted that given transistors switches algorithm does not supply a sine wave form of voltage in the phases of electric motor and it is impossible to change amplitude of variable voltage. For regulation of the amplitude it is necessary to use one of the zero combinations – (000) or (111), when there is no current in any leg. That further increases nonsensicalness of output voltage of the inverter.

To achieve sine wave form, it is necessary to use the intermediate state of the vector. If we take the position of the vector V_1 that matches with the state vector of keys (100), and the vector V_2 with the state vector of keys (110), then the projections V_α and V_β of the vector \bar{V} on the axes α and β will have the form $\bar{V} = V_\alpha + jV_\beta$ (Fig.2). In this form, the projections of V_α and V_β depend on the time when the vector \bar{V} stays in one of the extreme positions of the segment. $V_\alpha = V_{\alpha,100}t_1 + V_{\alpha,110}t_2$, and

$V_\beta = V_{\beta,100}t_1 + V_{\beta,110}t_2$. The total cycle time is $T_s = t_1 + t_2 + t_0 + t_{00}$, and the angle is $\theta = \omega_1 t_1$. [5]

Presentation of the main research

Zero conditions of transistors, apart from regulation of voltage vector amplitude, allow using the additional source of electric power. For example, to use the electrical energy from the solar panel (PV) in the vehicle, the electric power from it should flow to the DC-common bus by using DC / DC converter.[6] This design with multiple energy sources and an electric drive includes quite expensive components and the presence of two converters is not economically feasible. Consider a scheme that consists of interconnected sources of electrical energy (battery and solar panel), feeding the electric motor through a single converter (Fig.4) [7].

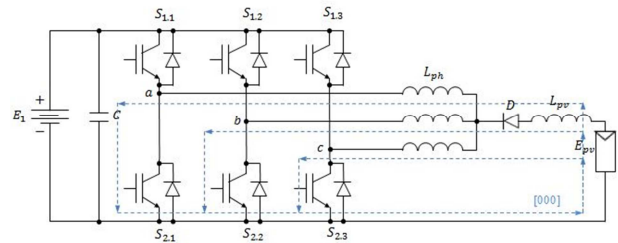

Fig.4. New electric vehicle drive scheme

In this scheme, the PWM is carried out using the zero states of the transistors, and the additional source is connected to the common (zero) point of the electric motor. For realization of the conditions of creation of space vector which is moved intermittently to angle $\pi/3$ counter-clockwise, the sequence of the transistors switching (100, 110, 010, 011, 001, 101, 100) was offered. In the circuit with the participation of the zero states of the transistors, the sequence (000, 100, 110, 111, 110, 100, 000) for the 1st sector, (000, 110, 010, 111, 010, 110, 000) for the 2nd sector, (000, 010, 011, 111, 011, 010, 000) for the 3rd sector, (000, 011, 001, 111, 001, 011, 000) for the 4th sector, (000, 001, 101, 111, 101, 001, 000) for the 5th sector, (000, 101, 100, 111, 100, 101, 000) for the 6th sector.[8]

It is necessary to consider in more details the combination for the 1st sector. It should be assumed that the electromotive force (EMF) of the E_{pv} source is lower than that of the E_1 source.[9] With operating state (000), the upper keys are closed. Voltage from E_1 source at phases "a", "b", and "c" of the electric motor is absent. Since E_{pv} source is connected at one terminal to "-" and the other to the common (zero) point of the electric motor, then with this combination of keys a discharge

circuit of the E_{pv} source arises through a common (zero) point in phase “a” to $S_{2,1}$ transistor, in phase “b” to $S_{2,2}$ transistor, in phase “c” to $S_{2,3}$ transistor and then to another source terminal (Fig.4). In this case, self-induction EMF is accumulated in the L_{pv} choke. [10]

Then comes the operating state (100). If the EMF of self-induction in the L_{pv} choke is enough for keeping the diode open, as the potential $\frac{E_1}{3}$ appears on its cathode (Fig.5), using the superposition principle, the current from the E_1 source arises in the phases of the motor, and the current from the E_{pv} source continues to flow in phases, changing its value according to the Kirchhoff Law. Thus, the magnitude of the total current from the two sources increases, which leads to an increase in the EMF in the phases.

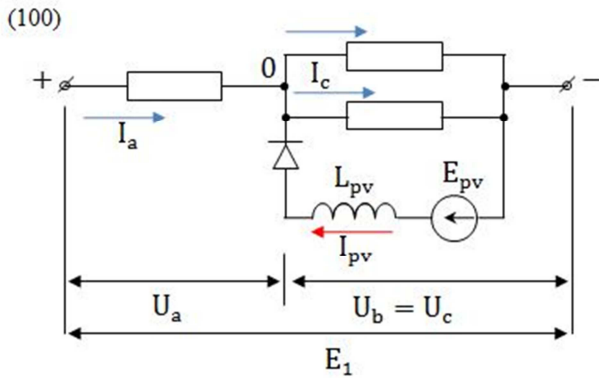

Fig.5 Equivalent circuit with additional power supply

After that, switching to the next operating state (110) takes place, where the current from the choke can flow through the phases of the electric motor until the potential at the anode of the diode decreases. Then comes the zero state (111). It should be noted that with a sufficiently high accumulated electrical energy in the L_{pv} choke, in the (111) state and in the regenerative mode of the electric motor, it is likely to be transferred to the capacitor C (Fig. 4). After (111) state goes reverse sequence of combinations (110, 100). In this period, transients associated with L_{pv} choke are completed (in this case, the regenerative mode of the electric motor is not considered) the potential at the anode of the diode becomes lower than at the cathode and the diode goes into the closed state. This condition continues until switching to the (000) state. Next, there is a transition to another sector with preservation of the conditions for energy transfer from the E_{pv} source. The considered switching sequence of transistors of the type (000,100, 110, 111, 110, 100, 000) is characterized by the following diagram of phase voltages (Fig. 6).

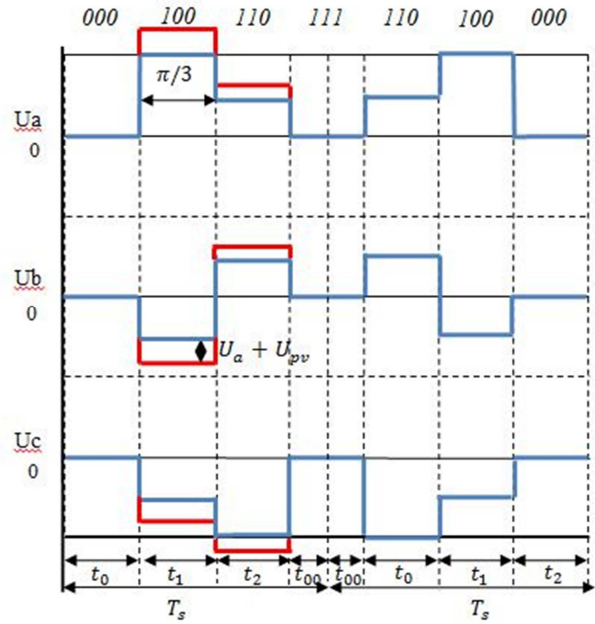

Fig.6 Phase voltage diagram with an additional source

Taking into account that the voltage increment is available only at the time period T_s of the first part of the cycle $2T_s$ (Fig.6), and at the beginning of the second part of the cycle $2T_s$ the process stops, it is possible to build the following vector voltage diagram for all sectors, marked in red (Fig. 7).

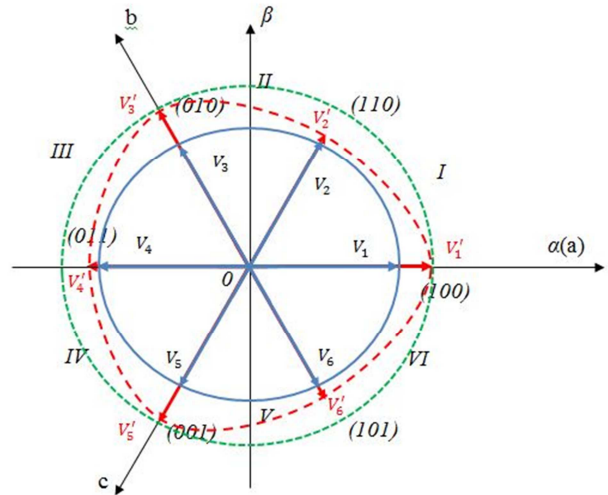

Fig.7 Voltage vector diagram for all sectors

In Figure 7, the amplitude of the voltage vectors under standard conditions are marked in blue. Further, it can be noted that at the point (100) the vector V_1 changes to the vector V_1' . In the second part of the cycle $2T_s$, the vector V_1' returns to the vector V_1 . At the point (110) the vector V_2 changes to the vector V_2' . After (111) state, the vector V_2' returns to the vector V_2 . For other sectors following algorithm is executed:

2nd sector: $0-V_2'-V_3'-0-V_3-V_2-0$

3rd sector: $0-V_3'-V_4'-0-V_4-V_3-0$

4th sector: $0-V_4'-V_5'-0-V_5-V_4-0$

5th sector: $0-V_5'-V_6'-0-V_6-V_5-0$

6th sector: $0-V_6'-V_1'-0-V_1-V_6-0$

Thus, it is possible to determine individual points (100), (010), (001) in the diagram, where, under fixed conditions, a change in the amplitude of the voltage vectors occurs. If we consider the condition that the electric energy accumulated in the L_{pv} choke is sufficient for the whole cycle $2T_s$, then the amplitude of the voltage vectors (Fig.7) will grow to the state indicated in green.

Conclusions

This combined function directly converts the PV-energy and energy from the battery, depending on the needs of the electric vehicle drive. New available power can be used in addition to battery power. The considered scheme ensures the flow of current from two sources simultaneously in all phases, but of different directivity and size. Thus, two three-phase voltage systems are formed. The three-phase voltage system from source E_{pv} is superimposed on the three-phase voltage system from source E_1 and creates a voltage vector that rotates at the same speed, but with variable amplitude.

Main points:

1. The new scheme and algorithm make it possible to combine the AC and DC components with a single converter.

2. The connection of the second source through a common (zero) point and the above control algorithm regulate the average values of current and voltage.

3. The voltage vectors reach the maximum value in the state (100), (010), (001), that is, every 120 degrees.

4. Under certain conditions, it is possible to transfer the accumulated electrical energy to the capacitor of the drive system of a hybrid or electric vehicle.

References

1. O. Salari ; K. Hashtrudi Zaad ; A. Bakhshai ; P. Jain, "Hybrid Energy Storage Systems for Electric

Vehicles: Multi-Source Inverter Topologies", 2018 14th International Conference on Power Electronics (CIEP), 24-26 Oct. 2018, Cholula, Mexico, DOI: 10.1109/CIEP.2018.8573377

2. Anto A., Streethumol M.V., "Review of electric vehicles", 2018 International Conference on Control, Power, Communication and Computing Technologies, ICCPCCT 201812 December 2018, Article # 8574304, Pages 392-398, DOI: 10.1109/ICCPCCT.2018.8574304

3. Mart van der Kam, Wilfried van Sark, "Smart charging of electric vehicles with photovoltaic power and vehicle-to-grid technology in a microgrid; a case study", Applied energy, Volume 152, August 05, 2015, Pages 20-30, DOI: 10.1016/j.apenergy.2015.04.092

4. Nayak P., Pramanick S.K., Rajashekara K., "A Soft-Switched PWM Technique for a Single Stage Isolated DC-AC Converter with Synchronous Rectification", 2018 IEEE Energy Conversion Congress and Exposition, ECCE 20183 December 2018, Article # 8557670, Pages 6733-6738

5. A Benmouna, M Becherif, D Depernet, MA Ebrahim, (2018) "Novel Energy Management Technique for Hybrid Electric Vehicle via Interconnection and Damping Assignment Passivity Based Control" Renewable Energy 119, 116-128.

6. M. Neuburger, M. Bargende, HC. Reuss, J. Wiedemann, "Photovoltaic based inverter charger" in Internationales Stuttgarter Symposium. Proceedings, Wiesbaden: Springer Vieweg, vol. 14, 2014.

7. M. Neuburger, J. Haag, "Photovoltaik im Elektrofahrzeug," Forschungsreport für die Elektrotechnik in Baden Württemberg 2014, ISSN 2199-4889, pp. 14-17,2015

8. A. Beshta ; O. Aziukovskyi ; A. Balakhontsev ; A. Shestakov, "Combined power electronic converter for simultaneous operation of several renewable energy sources", 2017 International Conference on Modern Electrical and Energy Systems (MEES) , Kremenchuk, Ukraine 10.1109/MEES.2017.8248898

9. Beshta, O. Balakhontsev, A. Albu, A., "Design of electromechanical system for parallel hybrid electric vehicle", Energy Efficiency Improvement of Geotechnical Systems - Proceedings of the International Forum on Energy Efficiency, 2013 | conference-paper, EID: 2-s2.0-84892160904

10. Beshta, O.S., Fedoreiko, V.S., Palchyk, A.O., Burega, N.V., Autonomous power supply of the objects based on biosolid oxide fuel systems, Naukovyi Visnyk Natsionalnoho Hirnychoho Universytetu, Issue 2, 2015, Pages 67-73

Мета. Розробка принципу побудови системи керування інвертором для одночасного управління потоками енергії від двох джерел постійного струму в приводі електричного транспортного засобу

Методологія. При проведенні досліджень режимів роботи компонентів змінного і постійного струму за допомогою одного перетворювача використовувалися методи математичного та імітаційного моделювання. Також застосований метод порівняльного аналізу для вибору оптимального способу реалізації алгоритму управління.

Результати. Показана працездатність схеми подвійного живлення асинхронного двигуна від двох джерел постійного струму за допомогою одного інвертора. У роботі наведені принципи побудови і наданий алгоритм керування транзисторами в такій схемі, описані її фізичні процеси і характеристики двигуна.

Наукова новизна. Підключення джерела постійного струму до загальної (нульовий) точки електричного двигуна змінного струму при його живленні від трифазного перетворювача дозволяє передавати енергію в електричний двигун без додаткового перетворювача постійного струму. Формування спеціального закону управління ключами перетворювача для роздільного управління.

Практична значимість. Наведена схема є передумовою вирішення завдання об'єднання декількох джерел електричної енергії за допомогою комбінованого перетворювача, що спростить систему електроприводу в гібридних і електричних транспортних засобах.

Ключові слова. *електричний транспортний засіб, комбінований електромеханічний перетворювач, джерела постійного струму, електропривод*

Цель. Создание принципа построения системы управления инвертором для одновременного управления потоками энергии от двух источников постоянного тока в приводе электрического транспортного средства.

Методология. При проведении исследований режимов работы компонентов переменного и постоянного тока с помощью одного преобразователя использовались методы математического и имитационного моделирования. Также применен метод сравнительного анализа для выбора

оптимального способа реализации алгоритма управления.

Результаты. Показана работоспособность схемы двойного питания асинхронного двигателя от двух источников постоянного тока с помощью одного инвертора. В работе приведены принципы построения схемы, дан алгоритм управления транзисторами, описаны физические процессы и характеристики двигателя.

Научная новизна. Подключение источника постоянного тока к общей (нулевой) точке электрического двигателя переменного тока при его питании от трехфазного преобразователя позволяет передавать энергию в электрический двигатель без дополнительного преобразователя постоянного тока. Формирование специального алгоритма управления ключами преобразователя для раздельного управления.

Практическая значимость. Приведенная схема является предпосылкой решения задачи объединения нескольких источников электрической энергии с помощью комбинированного преобразователя, упростит систему электропривода в гибридных и электрических транспортных средствах.

Ключевые слова. *электрическое транспортное средство, комбинированный электромеханический преобразователь, источники постоянного тока, электропривод.*

Рекомендовано до публікації докт. техн.. наук О.В. Садовим. Дата надходження рукопису